

NO.	REVISION	DATE

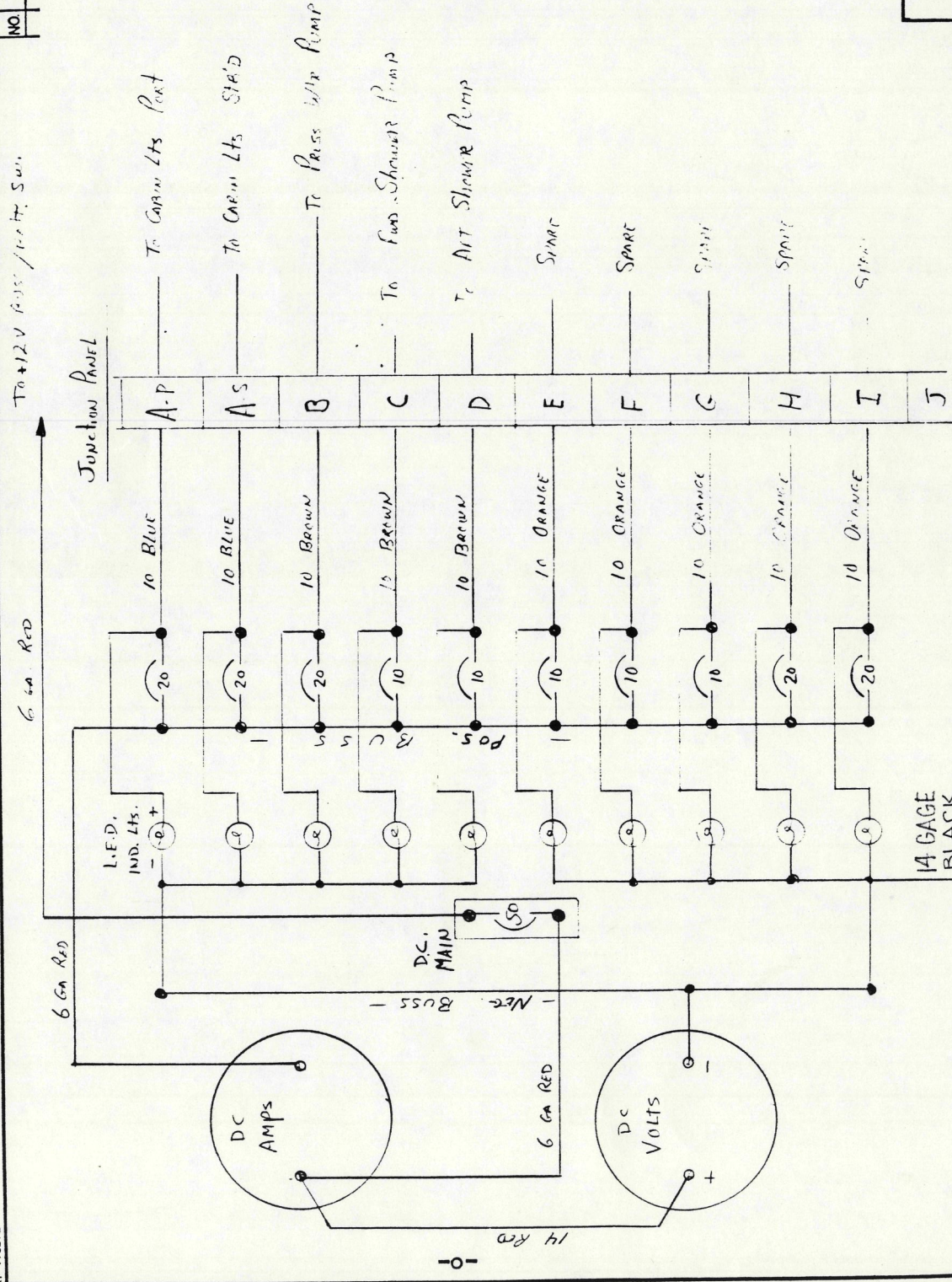

MORGAN YACHT CORP.
 7200 BRYAN DAIRY RD.
 ST. PETERSBURG, FLORIDA

416 - (Fis) DC Panel

DESIGNED BY	DATE	DRAWING NO.
CHECKED BY	11/20/80	416-215
APPROVED BY	SCALE	

AF 11827B

NO.	REVISION	DATE

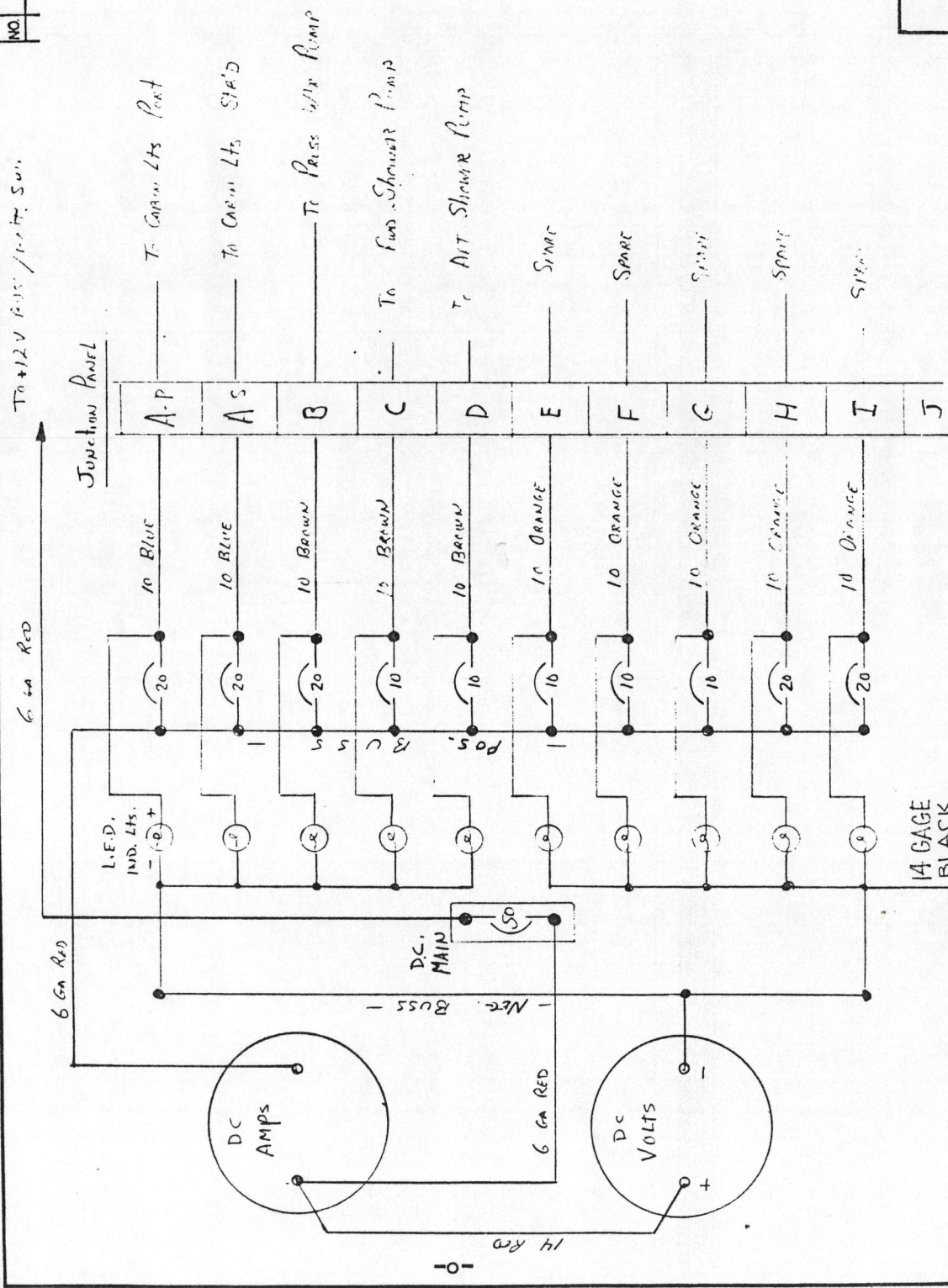

MORGAN YACHT CORP. 7200 BRYAN DAIRY RD. ST. PETERSBURG, FLORIDA	
DESIGNED BY	DRAWING NO.
DRAWN BY <i>DK</i>	416-215
CHECKED BY	DATE
APPROVED BY	11-20-80
	SCALE

416 - (His) DC Panel

4 HDRE
LINE #1

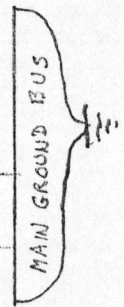
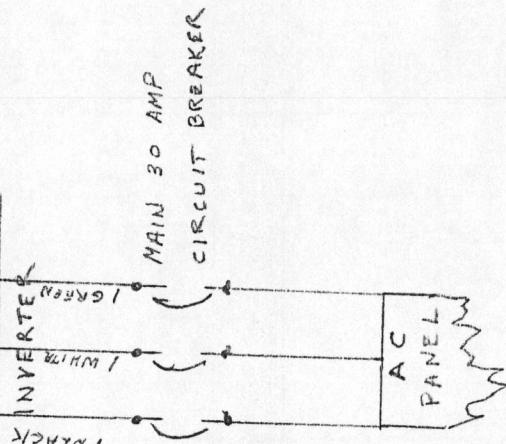
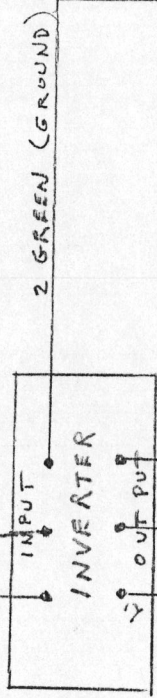
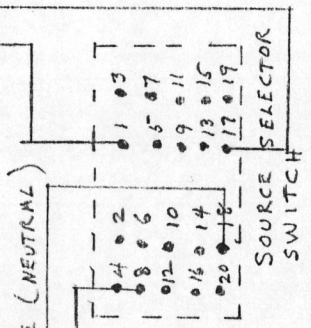
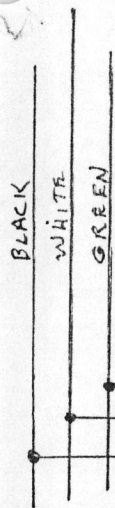

INVERTER WIRING
GAR 2/16/93

WIRE
LINE #1

BLACK
WHITE
GREEN

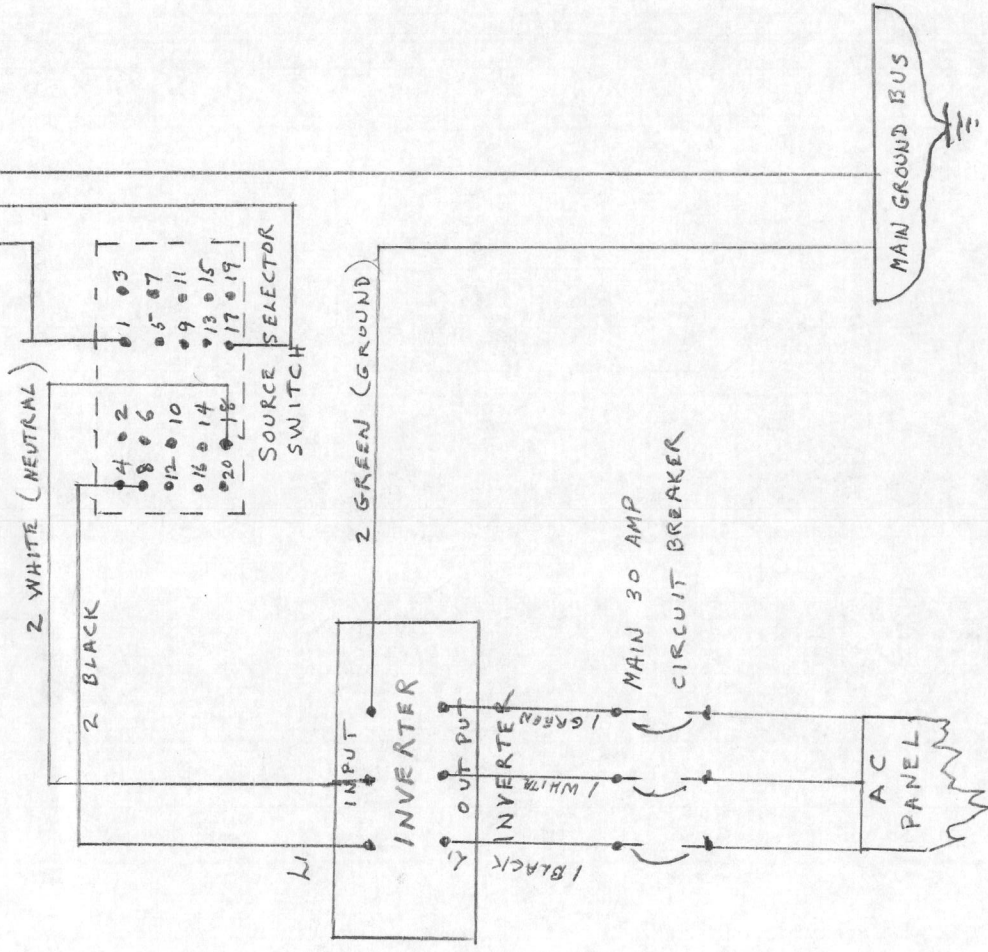

INVERTER WIRING

JAR 2/16/93

NO.	REVISION	DATE
-----	----------	------

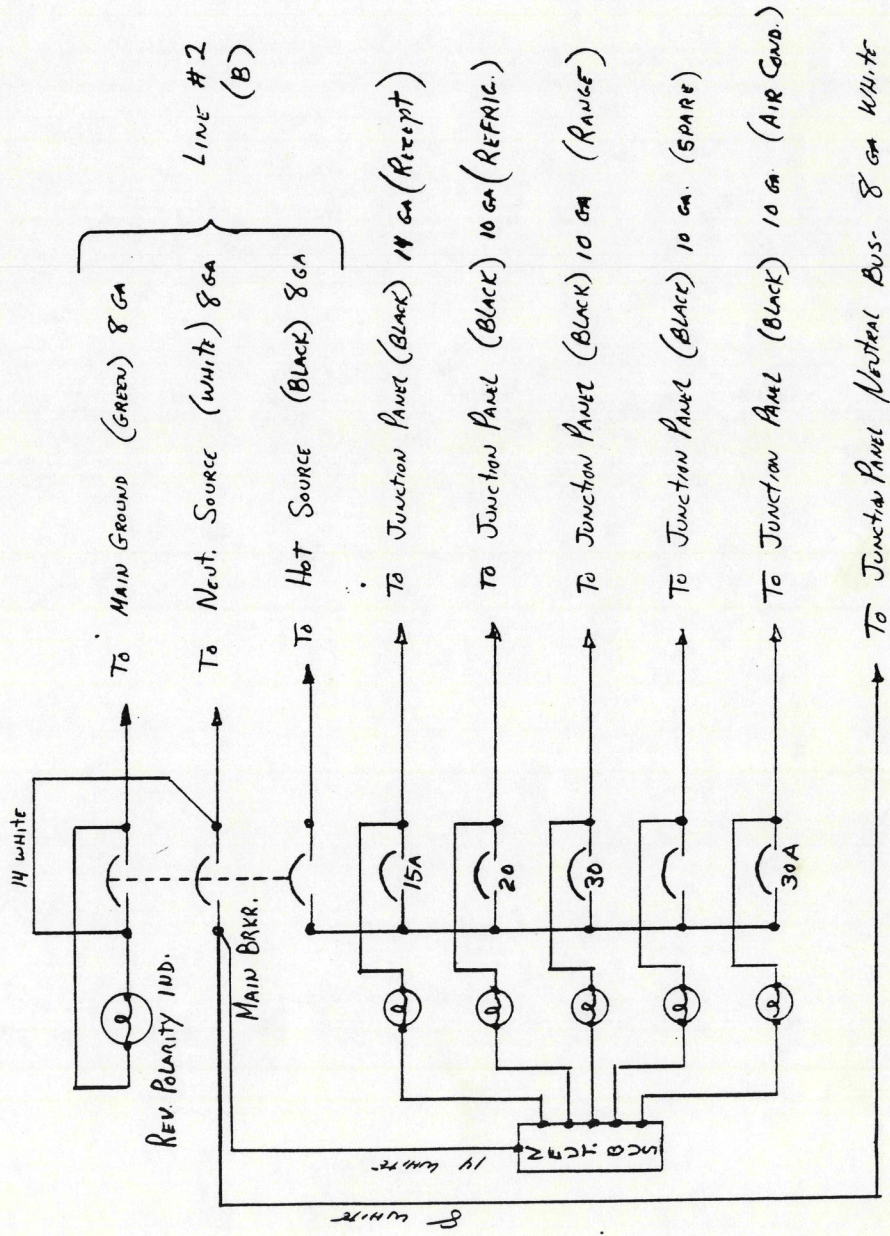

LINE #2
(B)

MYC P/N - 4010284

MORGAN YACHT CORP. 7200 BRYAN DAIRY RD. ST. PETERSBURG, FLORIDA	
DESIGNED BY KES AC Panel WIRING (Capt.)	DRAWING NO. 462-208
DRAWN BY [Signature]	DATE 2-16-79
CHECKED BY [Signature]	SCALE
APPROVED BY	

NO.	REVISION	DATE

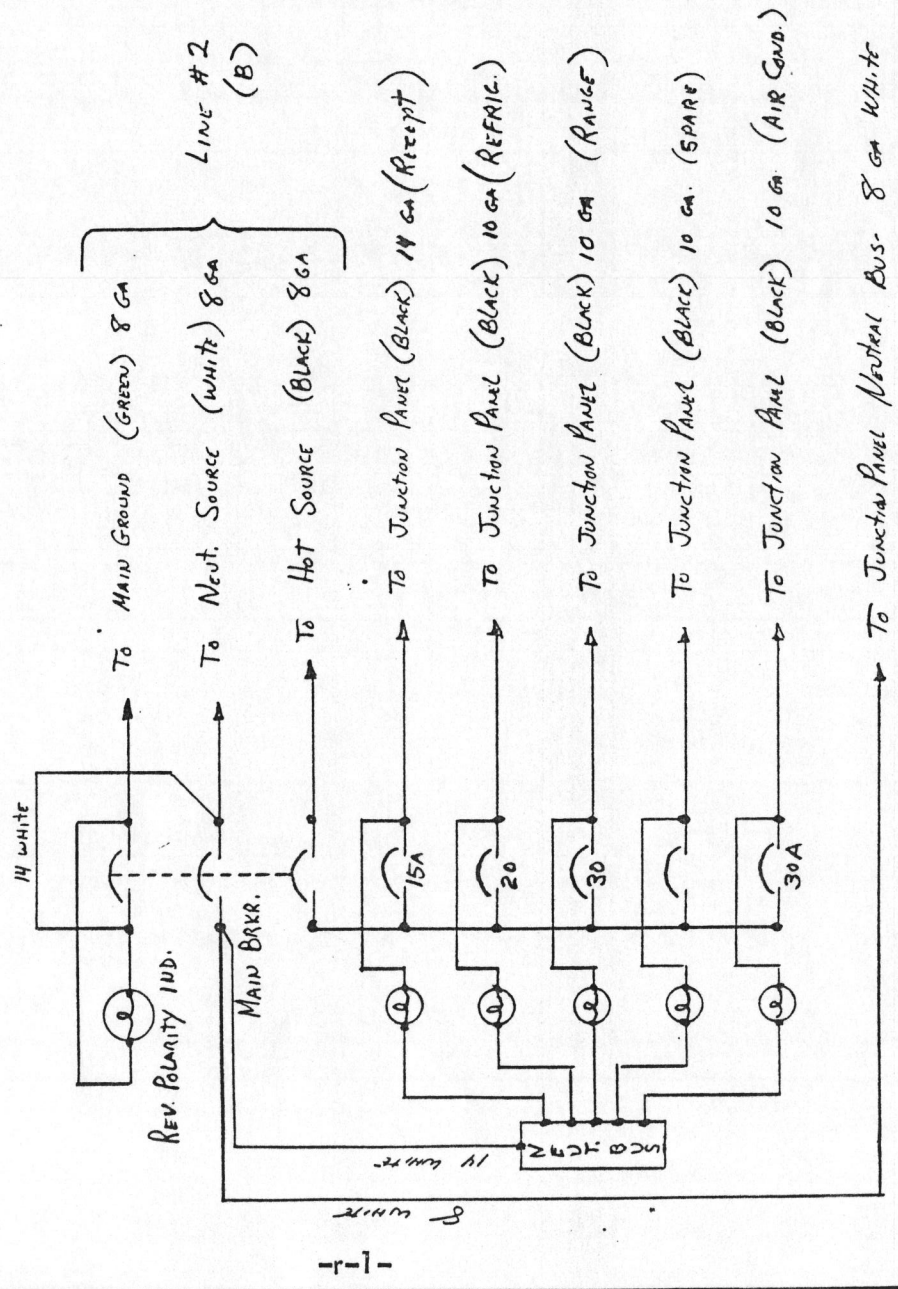

MYC P/N-4010284

MORGAN YACHT CORP. 7200 BRYAN DAIRY RD. ST. PETERSBURG, FLORIDA	
DESIGNED BY KES AC Panel Wiring (Opt.)	DRAWING NO. 462-208
DRAWN BY [Signature]	DATE 2-16-79
CHECKED BY [Signature]	SCALE
APPROVED BY	

NO.	REVISION	DATE
-----	----------	------

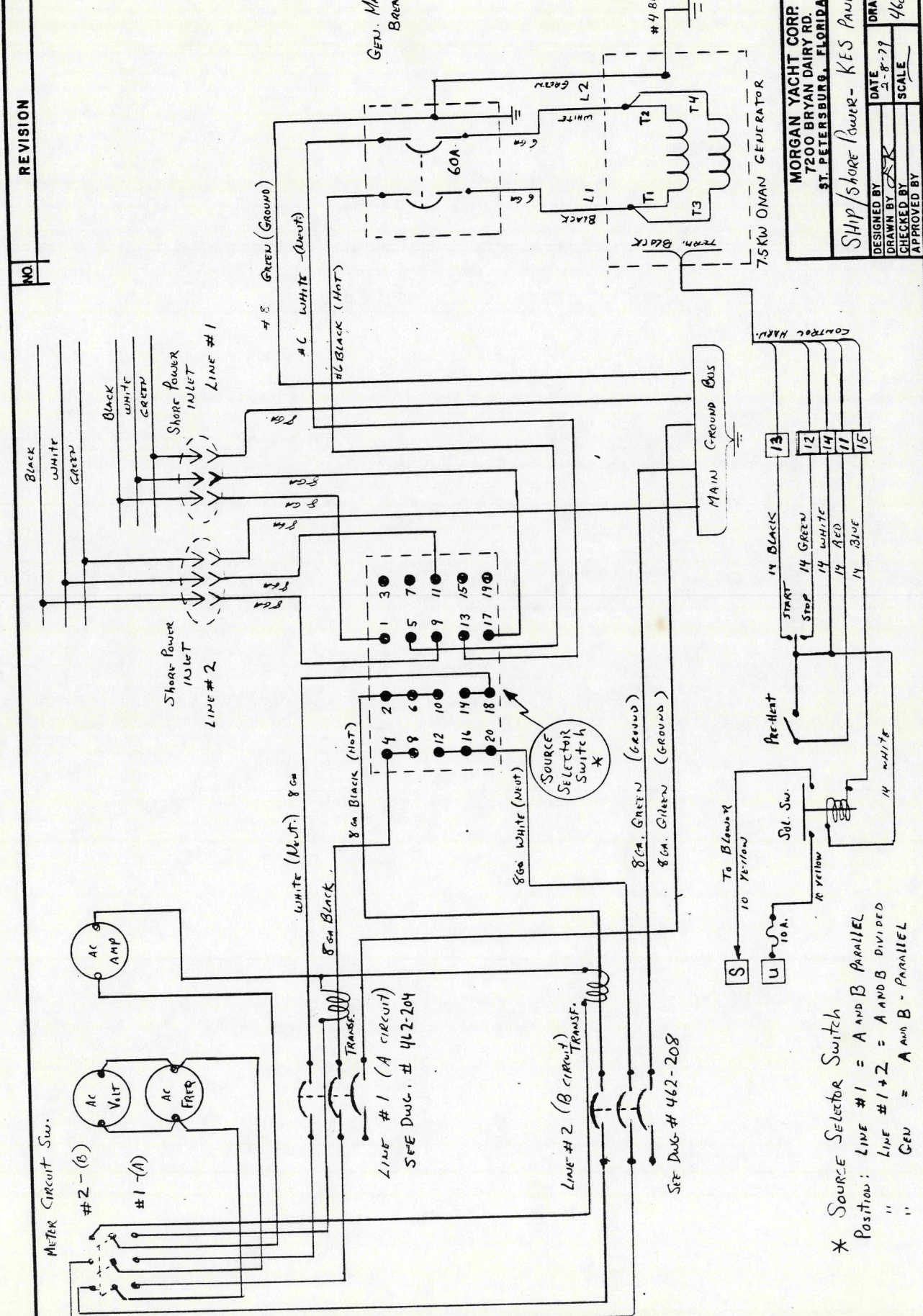

MORGAN YACHT CORP
 7200 BRYAN DAIRY RD.
 ST. PETERSBURG, FLORIDA

SHIP/Shore Power - KES Panel

DESIGNED BY	DATE	DRAWING NO.
DRAWN BY	2-8-79	462-205
CHECKED BY	SCALE	
APPROVED BY		

* SOURCE SELECTOR Switch
 Position: LINE #1 = A and B PARALLEL
 " LINE #1+2 = A and B DIVIDED
 " GEN = A and B - PARALLEL

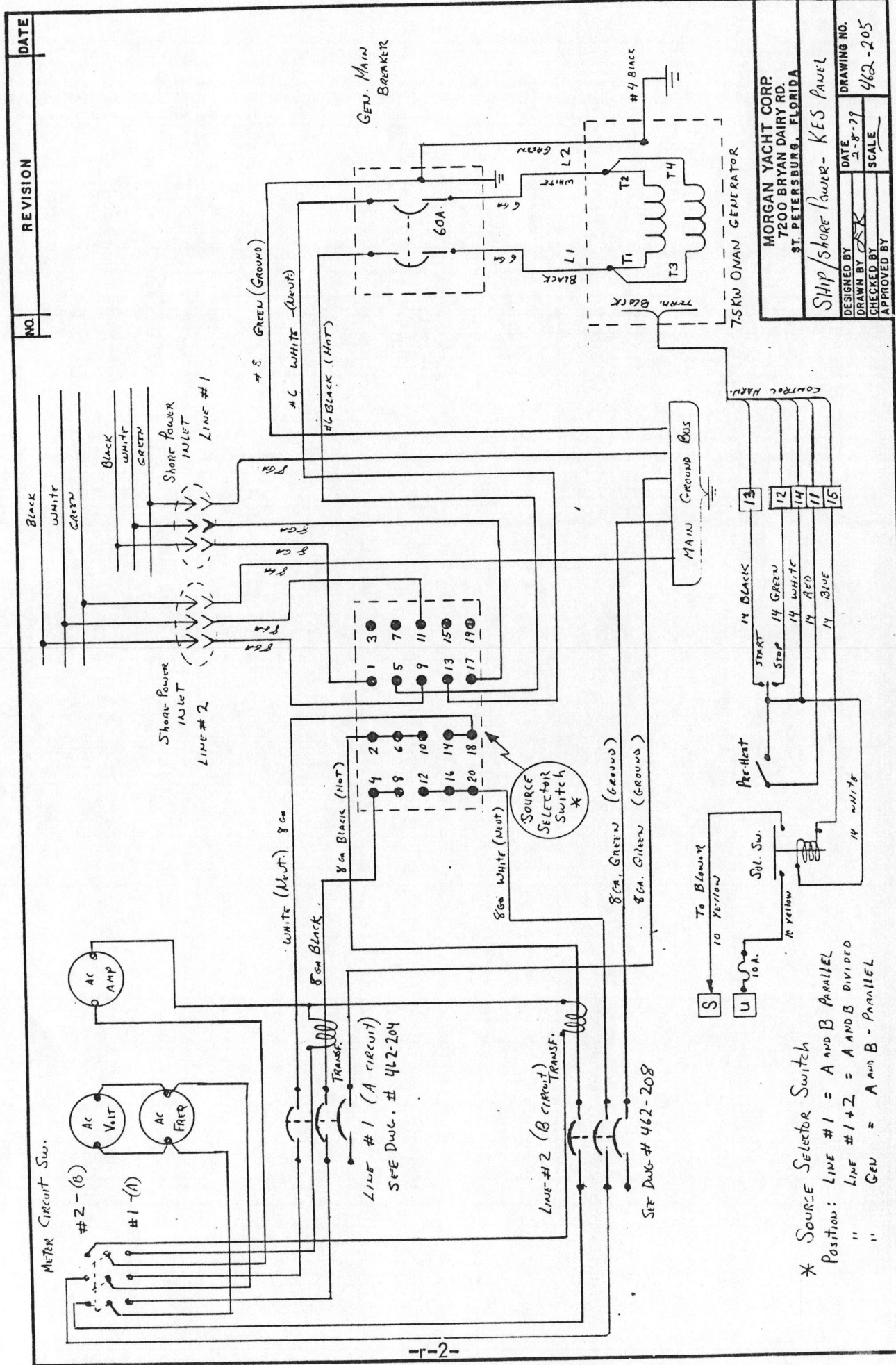

MORGAN YACHT CORP.
 7200 BRYAN DAIRY RD.
 ST. PETERSBURG, FLORIDA
 SHIP/SHORE Power - KES PANEL

DESIGNED BY	DATE	DRAWING NO.
DRAWN BY	2-8-77	462-205
CHECKED BY	SCALE	
APPROVED BY		

* SOURCE Selector Switch
 Position: LINE #1 = A AND B PARALLEL
 " " LINE #1+2 = A AND B DIVIDED
 " " GEN = A AND B - PARALLEL

NO.	REVISION	DATE

NO.	REVISION	DATE

D.C. MAIN PANEL
SEE DWG. TYP-241-1
FOR DETAIL

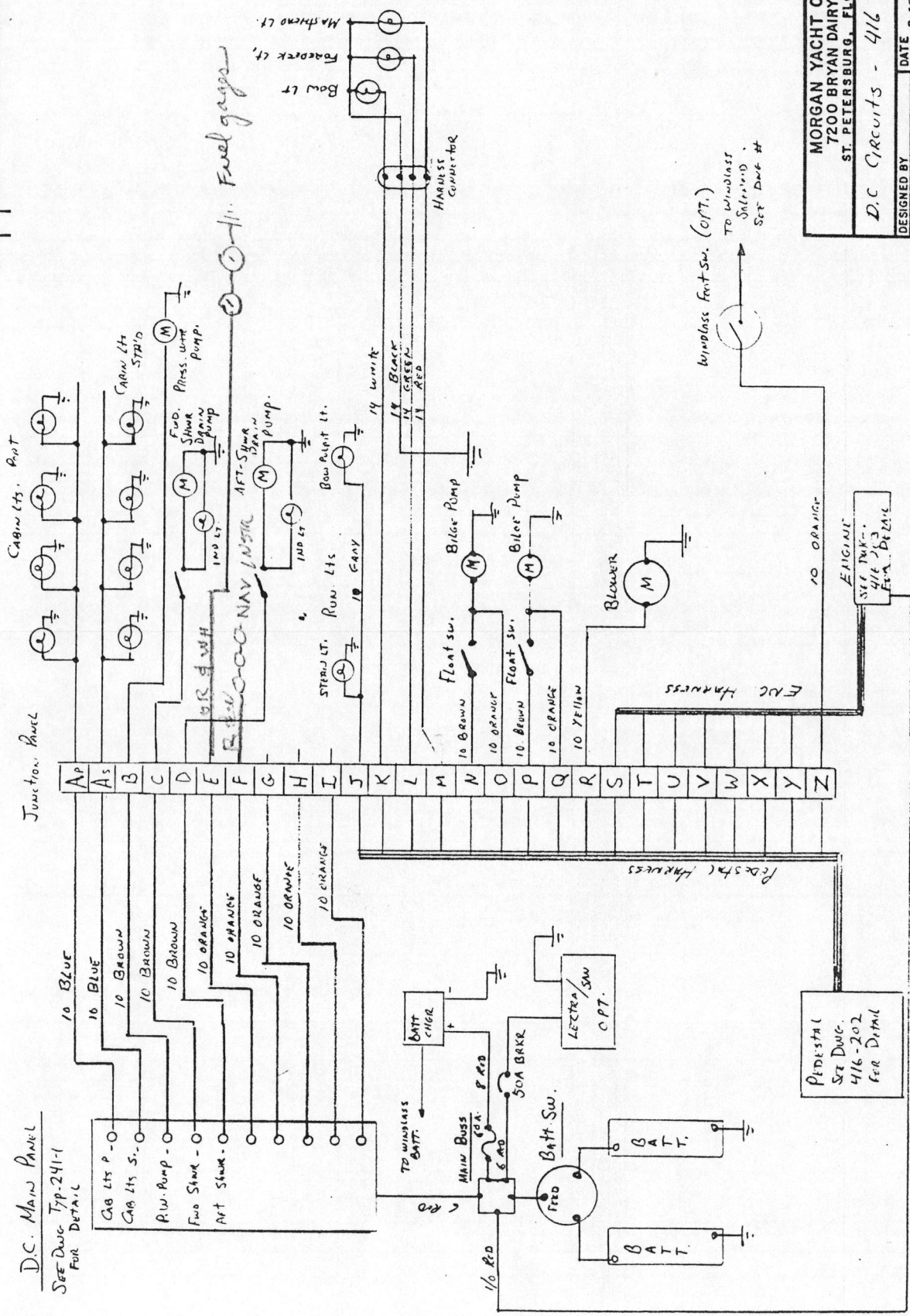

PEDestal
SEE DWG.
416-202
FOR DETAIL

ENGINE
SEE DWG.
416-203
FOR DETAIL

MORGAN YACHT CORP. 7200 BRYAN DAIRY RD. ST. PETERSBURG, FLORIDA	
DESIGNED BY	DATE
DRAWN BY	12-3-60
CHECKED BY	SCALE
APPROVED BY	416-209
D.C. Circuits - 416	

NO.	REVISION	DATE
-----	----------	------

D.C. MAIN PANEL
SEE DWG. TYP-241-1
FOR DETAIL

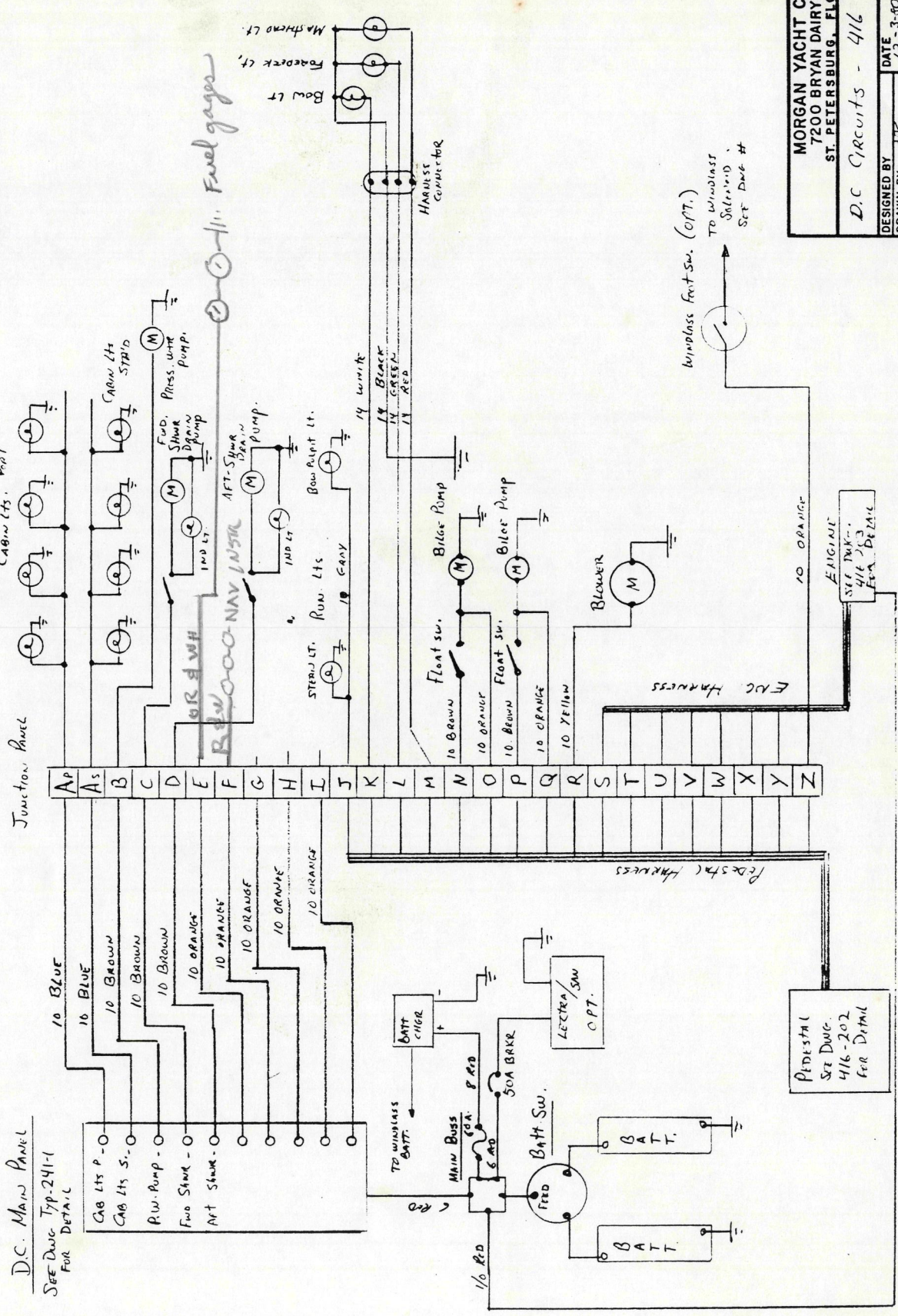

MORGAN YACHT CORP. 7200 BRYAN DAIRY RD. ST. PETERSBURG, FLORIDA	
DESIGNED BY	D.C. Circuits - 416
DRAWN BY	DATE 12-3-50
CHECKED BY	SCALE
APPROVED BY	DRAWING NO. 416-209

NO.	REVISION	DATE

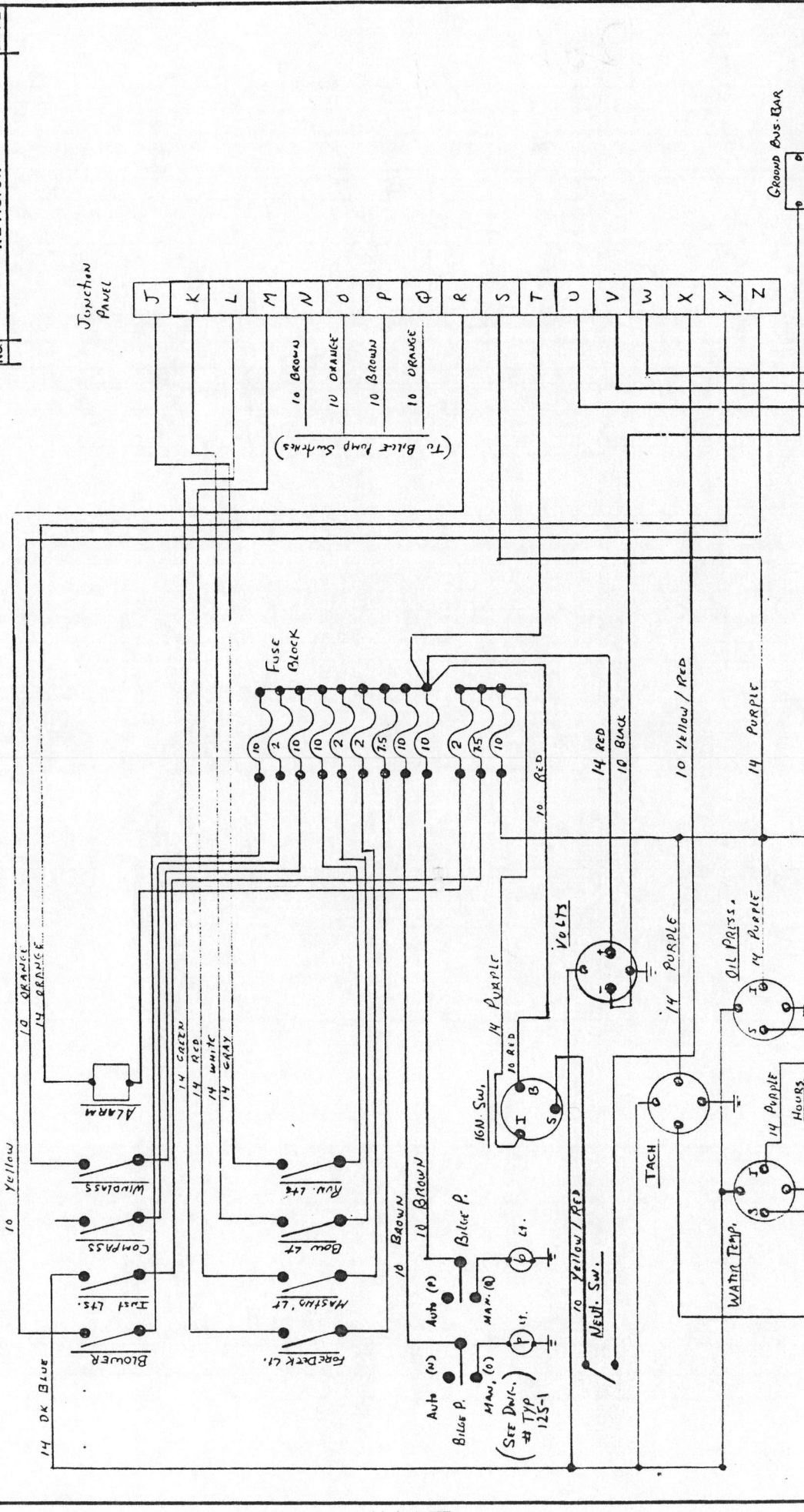

Ground Bus Bar

MORGAN YACHT CORP.
7200 BRYAN DAIRY RD.
ST. PETERSBURG, FLORIDA

PEDESTAL WIRING 416

DESIGNED BY	DATE	DRAWING NO.
C.R.	11-12-80	416-202
CHECKED BY	SCALE	
APPROVED BY		

AF 11527B

NO.	REVISION	DATE

AF 11527B

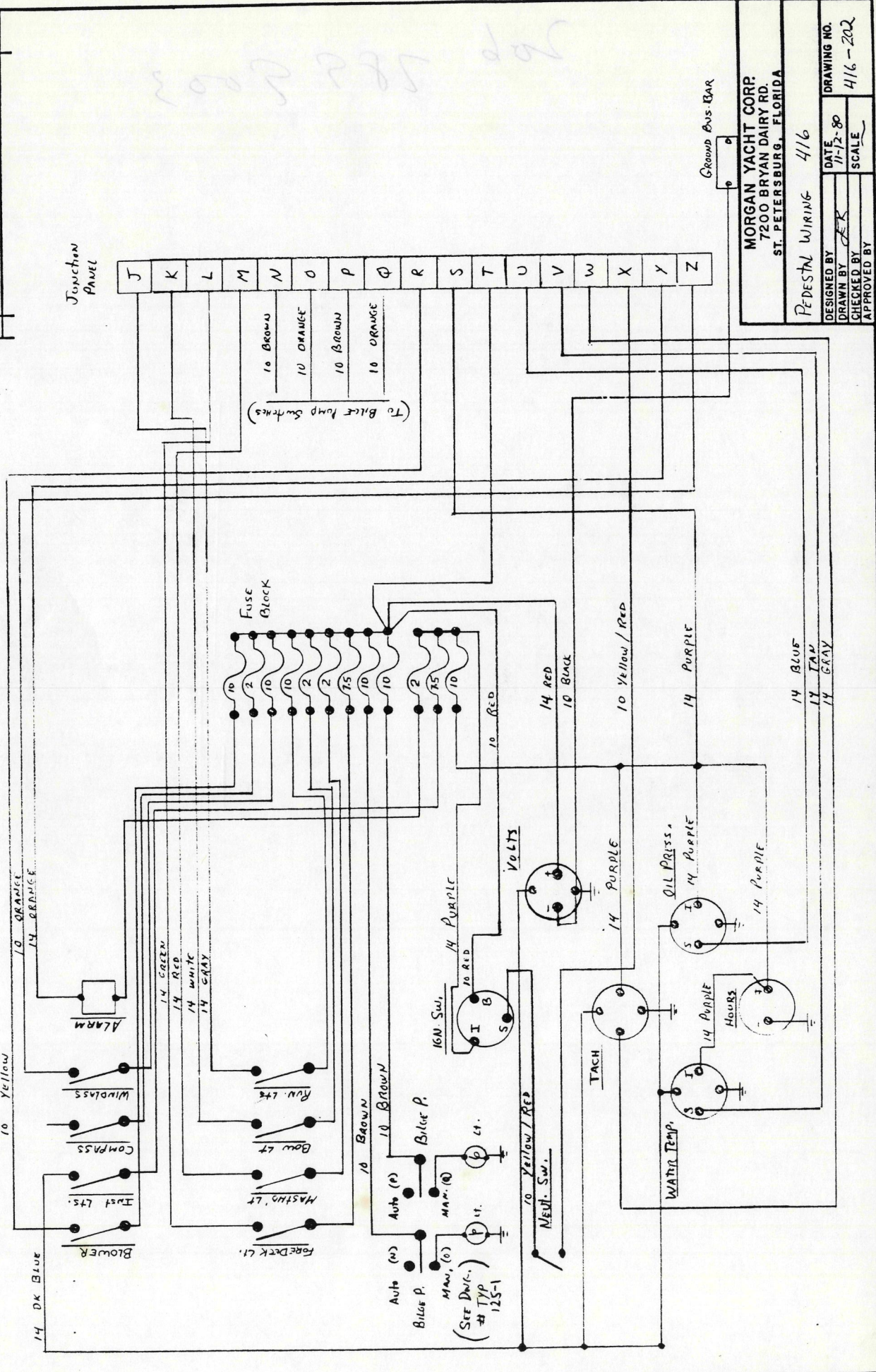

Junction Panel

(To Bilge Pump Switches)

Ground Bus-Bar

MORGAN YACHT CORP. 7200 BRYAN DAIRY RD. ST. PETERSBURG, FLORIDA	
DESIGNED BY	DATE
DRAWN BY	11-12-80
CHECKED BY	SCALE
APPROVED BY	41/6 - 202

PEDESTAL WIRING 41/6

NO.	REVISION	DATE
(1)	Connect Voltmeter to INSTR. circuit	1-5-51

JUNCTION PANEL

- J
- K
- L
- M
- N
- O
- P
- Q
- R
- S
- T
- U
- V
- W
- X
- Y
- Z
- /

- 10 BROWN
- 10 ORANGE
- 10 BROWN
- 10 ORANGE

(To Bilge Pump Switches)

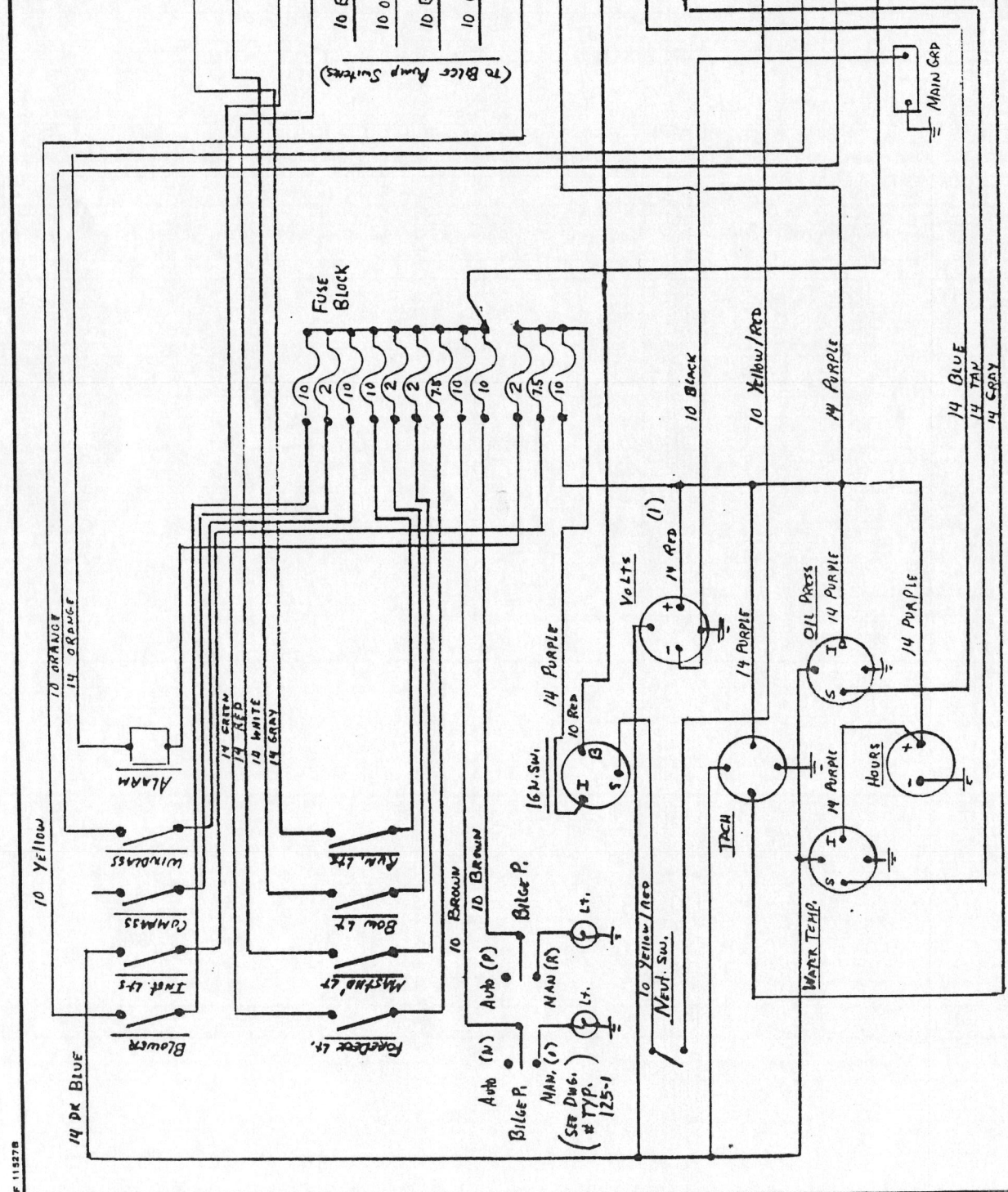

MORGAN YACHT CORP.
7200 BRYAN DAIRY RD.
ST. PETERSBURG, FLORIDA

DESIGNED BY *PK* DATE 11-23-51
DRAWN BY *PK* SCALE
CHECKED BY
APPROVED BY

PEDESTAL WIRING / DUAL ALTERNATORS
DRAWING NO. 416-225

AF 115278

NO.	REVISION	DATE
(1)	Connect bilge pump to insta. circuit	1-5-81

JUNCTION PANEL

- J
- K
- L
- M
- N
- O
- P
- Q
- R
- S
- T
- U
- V
- W
- X
- Y
- Z
- /

10 BROWN
10 ORANGE
10 BROWN
10 ORANGE
(To Bilge Pump Switches)

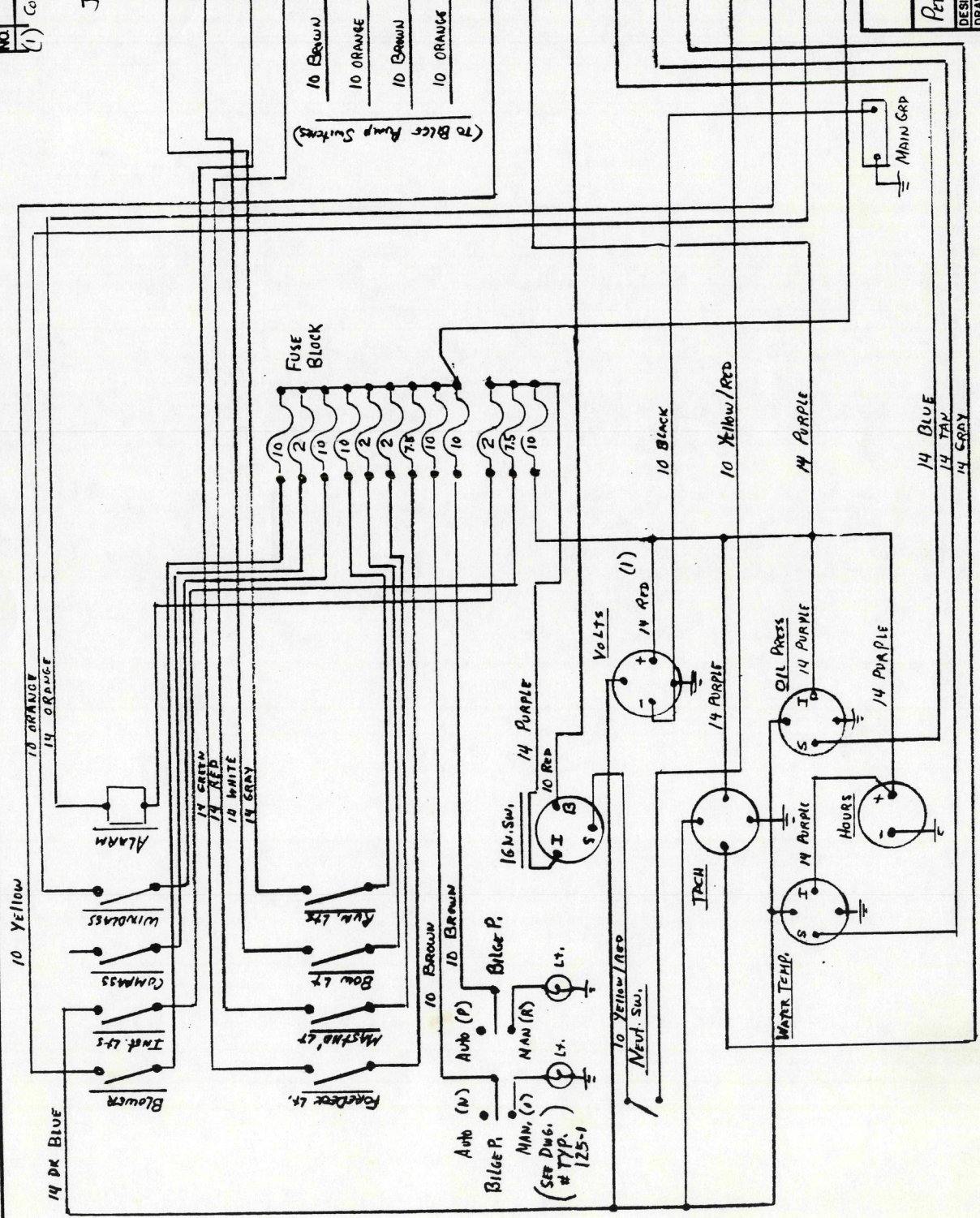

MORGAN YACHT CORP.
7200 BRYAN DAIRY RD.
ST. PETERSBURG, FLORIDA

DESIGNED BY [Signature]
DRAWN BY [Signature]
CHECKED BY [Signature]
APPROVED BY [Signature]

DATE 11-23-81
SCALE
DRAWING NO. 416-225

Pedestal WIRING / DUAL Alternators

AF 11527B

NO.	REVISION	DATE
1	ADD (C to) Breaker	11/26/64

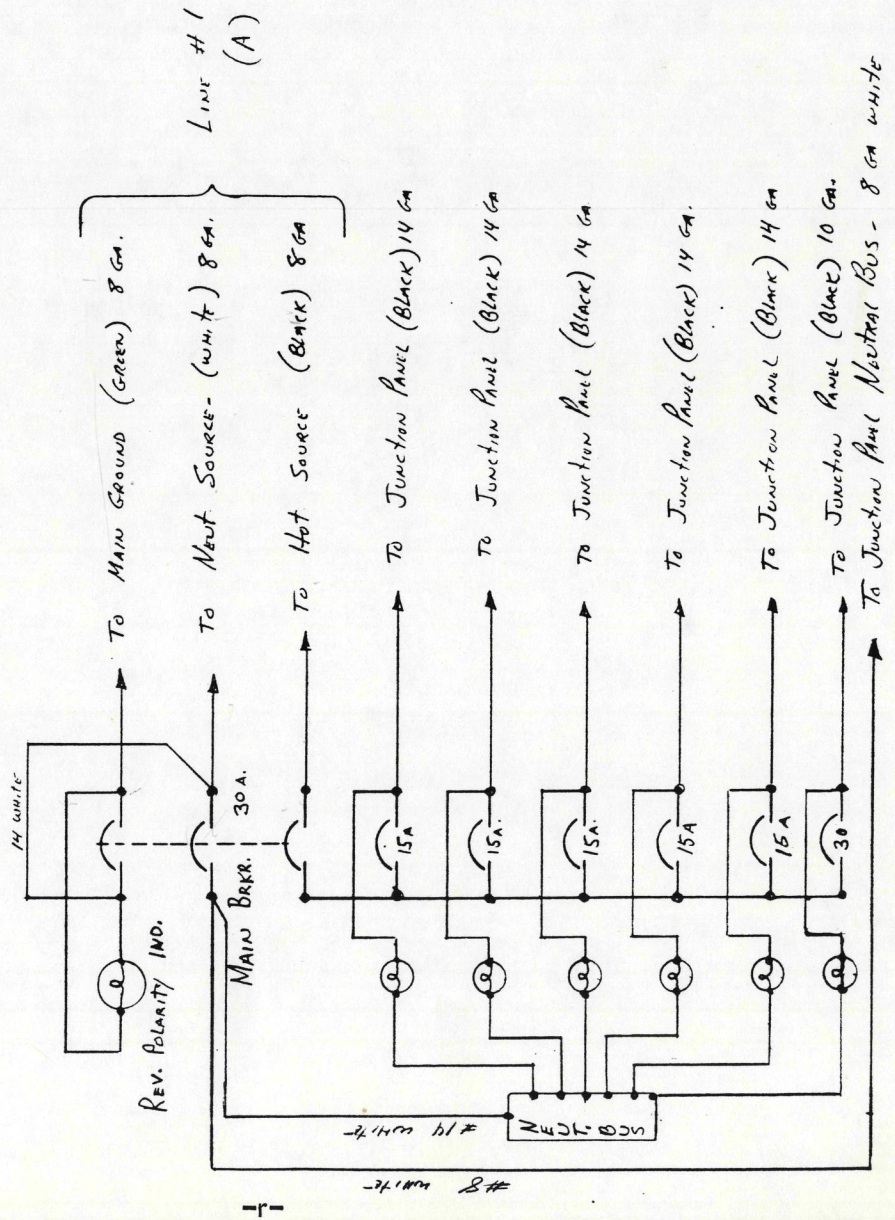

MYC P/N. 4010283

MORGAN YACHT CORP.
7200 BRYAN DAIRY RD.
ST. PETERSBURG, FLORIDA

KES AC PANEL WIRING (STD)

DESIGNED BY	DATE	DRAWING NO.
DRAWN BY	2-9-79	462-204
CHECKED BY	SCALE	
APPROVED BY		

NO.	REVISION	DATE
1	ADD (C.H.) Diagram	11/24/88

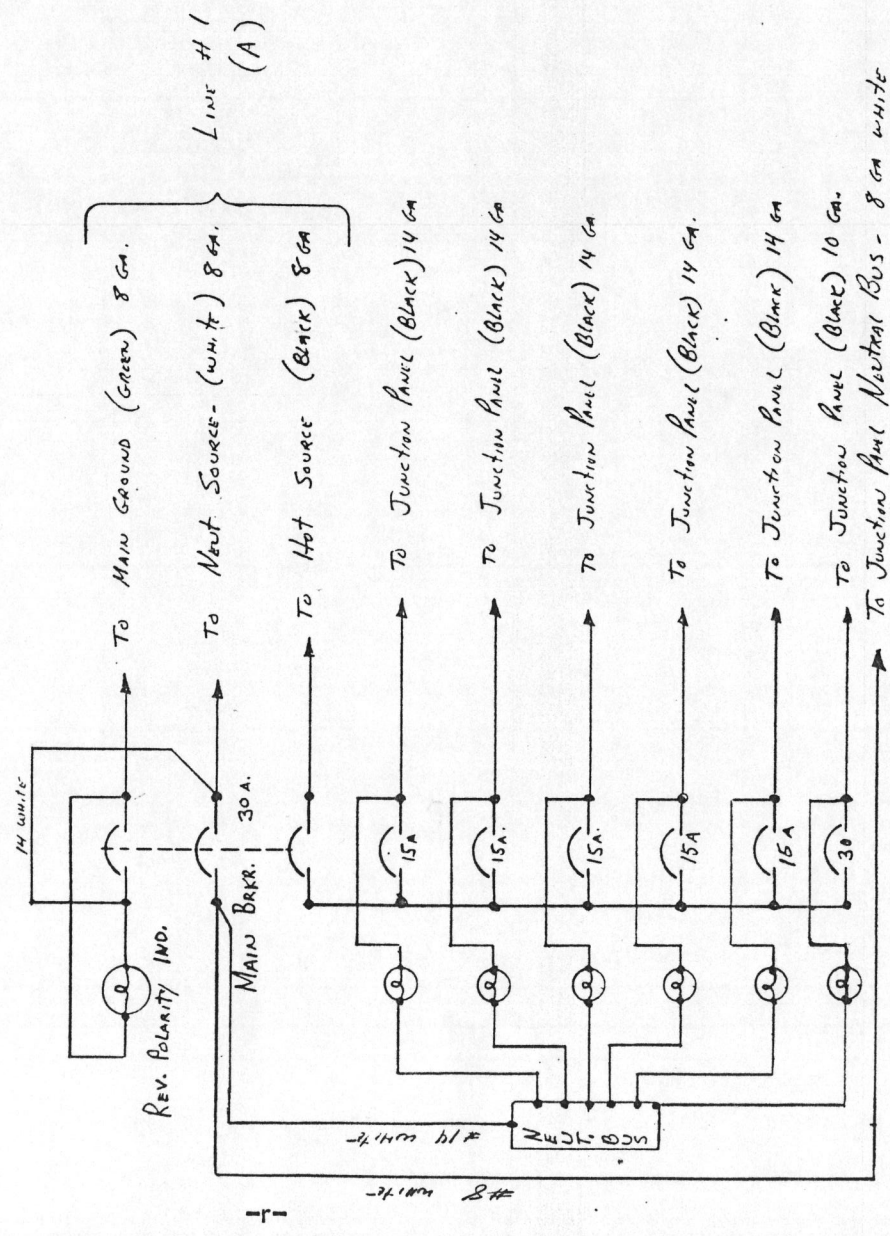

MYC P/N-4010283

MORGAN YACHT CORP.
7200 BRYAN DAIRY RD.
ST. PETERSBURG, FLORIDA

KES AC PANEL WIRING (STD)

DESIGNED BY	DATE	DRAWING NO.
DRAWN BY	2-9-79	462-204
CHECKED BY	SCALE	
APPROVED BY		